





Informazioni prodotto
Product information

-  Corrente costante
Constant current
-  Angolo del fascio luminoso
Beam angle
-  Modulo LED da incorporare
Built-in lighting module
-  Dimmerabile
Dimmable
-  Schede LED per singolo pannello
LED boards for single panel

Scheda LED a corrente costante / Constant current LED board

Ø 281 mm

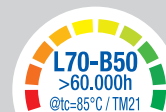
CL040_X2_BB**Descrizione / Description**

Scheda LED a corrente costante
Max 1400mA
Potenza max 106.5W
Flusso luminoso max 13109 lm
Dimmerabile con driver standard con tecnologia Dali, Triac, Push, 0-10V, 1-10V

Constant current LED board
Max 1400mA
Max power 106.5W
Max lumen 13109 lm
Dimmable with standard driver with Dali, Triac, Push, 0-10V, 1-10V technology

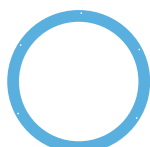
Varianti e accessori / Versions & accessoriesDa definire in fase d'ordine / *To be chosen when ordering*Pad termico biadesivo
*Biadhesive thermal pad*Cavo, tipo e lunghezza
Cable, type and lenght

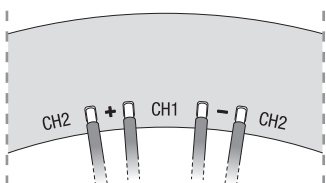
Informazioni tecniche
Technical information
Scheda LED a corrente costante / Constant current LED board
CL040_X2_BB
Cablaggio / Wiring

Conduttore rigido - *Solid conductor*
 Conduttore flessibile - *Stranded conductor*
 0.25~0.75mm² / AWG24-AWG18

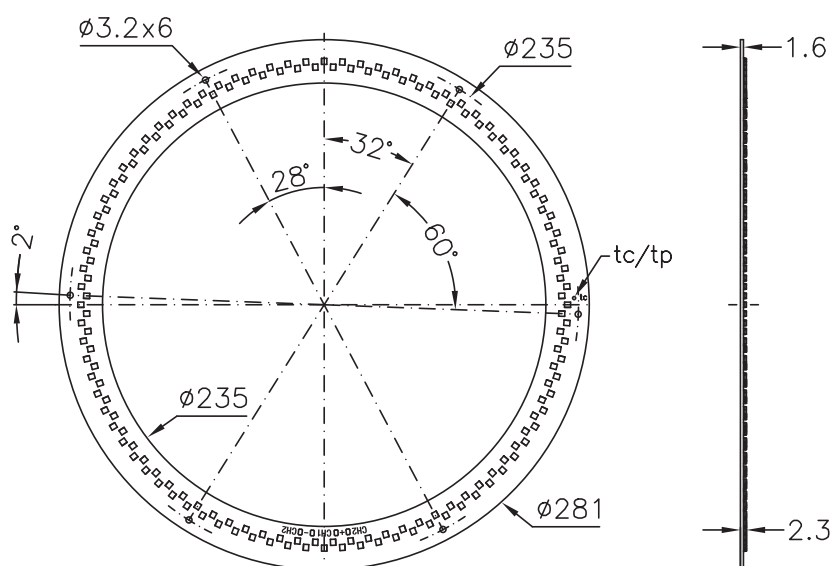
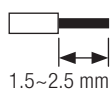

Dimensioni / Dimensions	Ø 281 mm - h 2.3 mm	
Tolleranze / Tolerances	Dimensionali / Dimensional: ±0.15mm - Spessore PCB / PCB thickness: ±10% - Ø fori / hole Ø: ±0.1mm	
Fissaggio / Fixing	Forie per fissaggio con viti e/o pad termico biadesivo (opzionale) Holes for screw fixing and/or biadhesive thermal pad (optional)	
PCB	IMS 1.6 mm	
Tipo LED / LED type	OSRAM® 2835	
Numero LED / LED q.ty	168 (84+84)	
Angolo del fascio luminoso / Beam angle	120°	
RA/CRI	Standard CRI>80, su richiesta / upon request CRI>90	
CCT	2700K, 3000K, 4000K, 6500K	
Step MacAdam (SDCM)	3	
R9	CRI 80	≥ 0
	CRI 90	≥ 50
Rischio fotobiologico / Photobiological risk	RG1	
Fattore di sopravvivenza / Survival factor	1	
Fattore mantenimento flusso luminoso / Luminous flux maintenance factor	@ 10000h / tc 85°C	= 0.97
	EPREL: @ 3000h / tc 85°C	= 0.96
Tensione max di lavoro degli isolamenti / Max working voltage of the insulations	60V	
Temperatura ambiente / Ambient temperature	ta: -20°C ~ +40°C	
Temperatura d'esercizio / Working temperature	tc: +90°C Da verificare sull'applicazione finale misurata sul tc / tp sulla scheda To be tested on final application measured at LED board tc / tp	
Temperatura nominale / Rated temperature	tp rated: 85°C	
Corrente nominale / Rated current	I rated: 1050mA	
Corrente massima / Max current	I max: 1400mA	
Dissipazione / Dissipation	Al fine di una corretta dissipazione la scheda deve essere fissata su una struttura in alluminio In order to obtain correct dissipation, fix the LED board to an aluminium support	

Valori ottici ed elettrici
Optical and electrical values

(@25°C)

Scheda LED a corrente costante / Constant current LED board

CLO40_X2_BB

Schema tipico di collegamento
Typical wiring

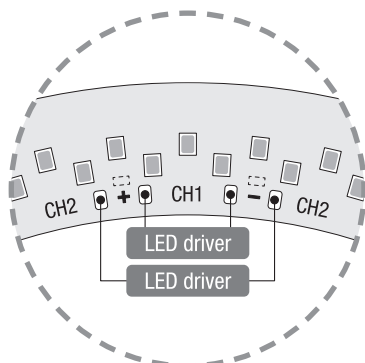

Un driver per ogni singolo circuito da 84 LED.
I due circuiti LED indipendenti possono essere alimentati separatamente o contemporaneamente per accensione singola o doppia.

N.B.: In caso di accensione singola i parametri elettrici di riferimento sono quelli riportati nella tabella a pagina 4.

*One driver for single circuit of 84 LEDs.
The two independent LED circuits can be powered separately or simultaneously for single or double ignition.*

N.B.: In case of single ignition, the electrical reference parameters are those shown in the table on page 4.

Curva tipica di distribuzione della luce
Luminous intensity distribution

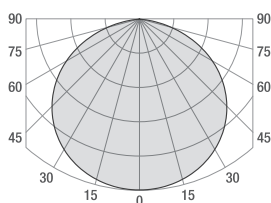

CC Input (mA) Ch1 / Ch2	V Typ (V) Ch1 / Ch2	Power Typ (W) Ch1 / Ch2
350 350	33.2 33.2	11.6 11.6
500 500	34 34	17 17
700 700	35 35	24.5 24.5
900 900	35.9 35.9	32.3 32.3
1050 1050	36.6 36.6	38.4 38.4
1400 1400	38 38	53.3 53.3

CCT	Power Typ (W) Ch1 + Ch2	CRI>80 / Ch1 + Ch2				CRI>90 / Ch1 + Ch2			
		Im Typ	Im/W	Energy efficiency	Photometric code	Im Typ	Im/W	Energy efficiency	Photometric code
2700K	23.3	3677	158		827/359	2950	127		
	34	5176	152			4234	125		
	49.1	7017	143			5772	118		
	64.6	8667	134			7156	111	A ₊ G ₊ F	927/359
	76.9	9825	128	A ₊ G ₊ E					
	106.5	12381	116						
3000K	23.3	3786	162		830/359	3052	131		
	34	5329	157			4380	129		
	49.1	7224	147			5971	122		
	64.6	8922	138			7577	117		930/359
	76.9	10114	132	A ₊ G ₊ E		8568	111	A ₊ G ₊ F	
	106.5	12745	120						
4000K	23.3	3894	167		840/359	3052	131		
	34	5481	161			4380	129		
	49.1	7430	151			5971	122		
	64.6	9177	142			7577	117		940/359
	76.9	10403	135	A ₊ G ₊ E		8568	111	A ₊ G ₊ F	
	106.5	13109	123						
6500K	23.3	3894	167		865/359	3052	131		
	34	5481	161			4380	129		
	49.1	7430	151			5971	122		
	64.6	9177	142			7577	117		
	76.9	10403	135	A ₊ G ₊ E		8568	111	A ₊ G ₊ F	
	106.5	13109	123						

Tolleranza valori / Values tolerances: ±10%

Mantenimento del flusso luminoso
Lumen maintenance

Forward current	tp temperature	L70 / B50
350mA~1050mA	55 °C	>60000 h
	70 °C	>60000 h
	85 °C	>60000 h

Valori ottici ed elettrici
Optical and electrical values

(@25°C)

Scheda LED a corrente costante / Constant current LED board

CLO40_X2_BB

Tabella di riferimento per i valori del singolo circuito
Reference table for individual circuit values

CC Input (mA)	V Typ (V)	Power Typ (W)
350	33	11.6
500	33.7	16.8
700	34.8	24.4
900	35.1	31.6
1050	35.8	37.5
1400	36.8	51.6

Curva tipica di distribuzione della luce
Luminous intensity distribution

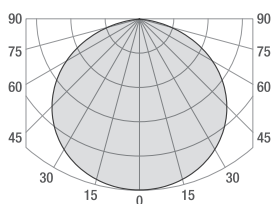

CCT	Power Typ (W)	Im Typ	CRI>80		Photometric code	CRI>90		Photometric code
			Im/W	Im Typ		Im/W		
2700K	11.6	1947	168		827/359	1594	137	927/359
	16.8	2694	160			2249	134	
	24.4	3655	150			3067	126	
	31.6	4537	144			3873	123	
	37.5	5146	137			4434	118	
	51.6	6358	123			5705	111	
3000K	11.6	2045	176		830/359	1649	142	930/359
	16.8	2830	168			2326	138	
	24.4	3839	157			3173	130	
	31.6	4717	149			4006	127	
	37.5	5351	143			4586	122	
	51.6	6747	131			5901	114	
4000K	11.6	2103	181		840/359	1682	145	940/359
	16.8	2911	173			2373	141	
	24.4	3948	162			3237	133	
	31.6	4852	154			4086	129	
	37.5	5504	147			4678	125	
	51.6	6940	134			6019	117	
6500K	11.6	2103	181		865/359			
	16.8	2911	173					
	24.4	3948	162					
	31.6	4852	154					
	37.5	5504	147					
	51.6	6940	134					

Tolleranza valori / Values tolerances: ±10%

Composizione codice ordine standard
Standard order code composition

Scheda LED a corrente costante / Constant current LED board

CL040_X2_BB

CL040 | XXXXX | X2 | XX | BB | YYYYYY

① | ② | ① | ③ | ① | ④

Codice fisso / Fixed code

①

CL040_X2_BB

CCT + SDCM

②

CRI>80

CRI>90

2700K

27803

27903

3000K

30803

30903

4000K

40803

40903

6500K

65803

/

Varianti standard
Standard variants

③

No pad

Pad termico biadesivo applicato
Biadhesive thermal pad applied

Senza cavi / Without cables

XX

XA

Con cavi / With cables

BX

BA

Varianti cavo / Cable variants

④

Da definire in fase d'ordine / To be chosen when ordering

Driver / Driver

Se non diversamente indicato, le schede LED non sono protette da sovratensioni, sovracorrenti, sovraccarichi o cortocircuiti. Per un buon funzionamento, assicurarsi che il driver utilizzato abbia tali protezioni.

Unless otherwise indicated, LED boards are not protected against overvoltage, overcurrent, overload or short-circuits. For correct operation, check driver has such protections.

Note / Notes

Le schede LED contengono componenti che sono sensibili alle scariche elettrostatiche e possono essere maneggiati solo utilizzando le adeguate protezioni. Durante le fasi di lavorazione è necessario prestare la massima attenzione a non danneggiare le schede e/o apportare modifiche alle stesse ed evitare di collegarle ad un driver sotto tensione.

LED boards contain components sensitive to electrostatic discharges and should be handled only using adequate protection. During assembly steps, be careful not to damage the LED boards and/or not to modify them. Avoid connecting the LED boards while the driver is being powered.

Riferimenti normativi / Normative requirements

EN 62031 / EN 62471 / IEC TR 62778

Note legali / Legal notes

Le informazioni contenute all'interno del presente documento devono intendersi come generali sulle caratteristiche e sull'utilizzo del prodotto. Essendo il prodotto LED in continua evoluzione, i dati riportati potranno subire variazioni senza obbligo alcuno di comunicazione o preavviso da parte di EA srl. EA srl non è responsabile per danni a cose o persone conseguenti ad un utilizzo improprio del prodotto o comunque ad una errata installazione dello stesso. I "diritti di proprietà intellettuale" (logo, disegni tecnici e/o foto, software e/o firmware) sono di esclusiva proprietà di EA srl.

The information contained in this document should be considered as general information on the characteristics and use of the product. Since LED products are continuously evolving, the above values are subject to change without any obligation of communication or notice from EA srl. EA srl will not be liable for any damage to property or people resulting from improper use of the products or from faulty installation of the latter. Intellectual property rights (logo, technical drawings and /or photos, software and/or firmware) are the exclusive property of EA srl.

EA srl

Strada degli Angariari, 25 | Zona Ind. Rovereta | 47981 Falciano | Repubblica di San Marino